

ENDOTECH

M E D I C A L S Y S T E M S

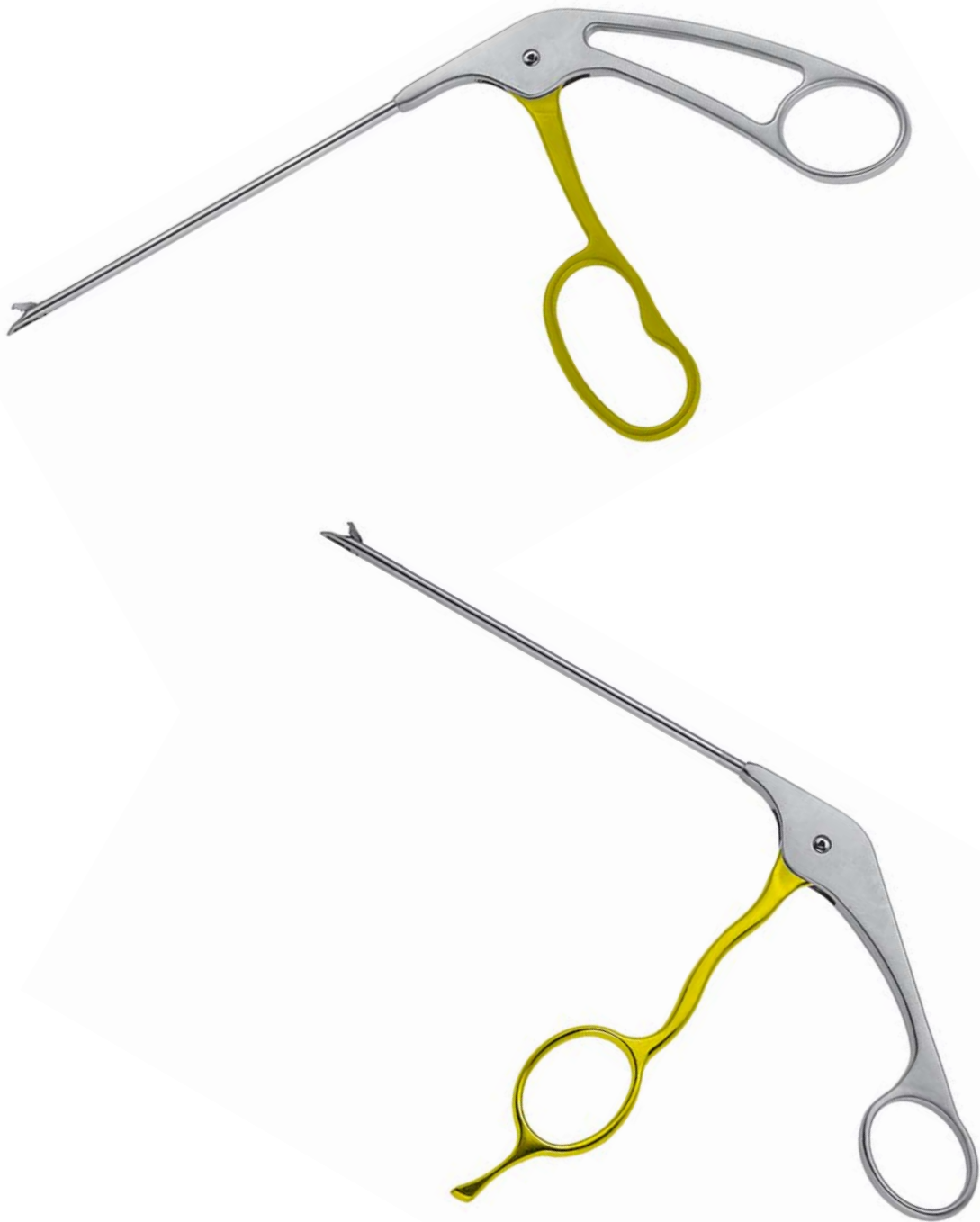

Arthroskopie Instrumente
Arthroscopy Instruments

Inhaltsverzeichnis Index

	Seite / Page
Arthroskopie Instrumente Arthroscopy Instruments	
Fig. 1	3 - 9
Fig. 2	11 - 17
Fig. 3	19 - 25
Fig. 4	27 - 33

Diese Broschüre bleibt ausschließlich Eigentum der Firma Endotec Medical Systems. Die Vervielfältigung, auch auszugsweise, ist nicht gestattet. Technische Änderungen und Druckfehler vorbehalten.

This brochure remains exclusive property of the company Endotec Medical Systems. Reprinting, even partially, is not allowed. Technical alterations and printing errors reserved.

Arthroskopie Instrumente
Arthroscopy Instruments

Fig. 1



Ergonomisch geformter Griff
Ergonomical formed Handle













ENDOTECH

M E D I C A L S Y S T E M S

Arthroskopie / Arthroscopy

Alle Instrumente mit Überlastungsschutz
All Instruments with Overload Protection















	ø mm	Hakenschere Hook Scissors	Hakenstanze mit Schaufel Hook Punch with Scoop	Hakenstanze abgesetzt Hook Punch set down	Hakenstanze Schnitt eckig Hook Punch Cut angular
			 L = 5,0 mm · B = 1,6 mm	 L = 5,0 mm · B = 1,6 mm	 L = 5,0 mm · B = 1,6 mm
gerade · straight	2,7	41-02502-70	41-02902-70	41-03502-70	
	3,5	41-02503-50	41-02903-50	41-03503-50	41-03703-50
30° rechts · 30° right	2,7	41-02512-70	41-02912-70	41-03512-70	
	3,5	41-02513-50	41-02913-50	41-03513-50	41-03713-50
30° links · 30° left	2,7	41-02532-70	41-02932-70	41-03532-70	
	3,5	41-02533-50	41-02933-50	41-03533-50	41-3733-50
45° rechts · 45° right	2,7	41-02552-70	41-02952-70	41-03552-70	
	3,5	41-02553-50	41-02953-50	41-03553-50	41-3753-50
45° links · 45° left	2,7	41-02572-70	41-02972-70	41-03572-70	
	3,5	41-02573-50	41-02973-50	41-03573-50	41-03773-50
7° auf · 7° up	2,7	41-02592-70	41-02992-70	41-03592-70	
	3,5	41-02593-50	41-02993-50	41-03593-50	41-03793-50
7° auf · 7° down	2,7	41-02612-70	41-03012-70	41-03612-70	
	3,5	41-02613-50	41-03013-50	41-03613-50	41-03813-50
15° auf · 15 up	2,7	41-02632-70	41-03032-70	41-03632-70	
	3,5	41-02633-50	41-03033-50	41-03633-50	41-03833-50
15° ab · 15° down	2,7	41-02652-70	41-03052-70	41-03652-70	
	3,5	41-02653-50	41-03053-50	41-03653-50	41-03853-50

Arthroskopie / Arthroscopy

Alle Instrumente mit Überlastungsschutz
All Instruments with Overload Protection



	ø mm	Hakenstanze 15° aufwärts gefräst Hook Hook Punch 15° up milled	Breitmaulstanze groß Wide Jaw Punch large	Breitmaulstanze mittel Wide Jaw Punch medium	Breitmaulstanze klein Wide Jaw Punch small
		 L = 5,0 mm · B = 1,6 mm	 L = 5,0 mm · B = 4,5 mm	 L = 5,0 mm · B = 3,5 mm	 L = 6,0 mm · B = 2,5 mm
gerade · straight 	3,5	41-03903-50	41-04903-50	41-05603-50	41-06303-50
30° rechts · 30° right 	3,5	41-03913-50	41-04913-50	41-05613-50	41-06313-50
30° links · 30° left 	3,5	41-03933-50	41-04933-50	41-05633-50	41-06333-50
45° rechts · 45° right 	3,5	41-03953-50	41-04953-50	41-05653-50	41-06353-50
45° links · 45° left 	3,5	41-03973-50	41-04973-50	41-05673-50	41-06373-50
7° auf · 7° up 	3,5	41-03993-50	41-04993-50	41-05693-50	41-06393-50
7° auf · 7° down 	3,5	41-04013-50	41-05013-50	41-05713-50	41-06413-50
15° auf · 15 up 	3,5	41-04033-50	41-05033-50	41-05733-50	41-06433-50
15° ab · 15° down 	3,5	41-04053-50	41-05053-50	41-05753-50	41-06453-50













ENDOTECH

M E D I C A L S Y S T E M S

Arthroskopie / Arthroscopy

Alle Instrumente mit Überlastungsschutz
All Instruments with Overload Protection



	ø mm	Breitmaulstanze groß 15°aufwärts gefräst Wide Jaw Punch large 15° up milled	Breitmaulstanze mittel 15°aufwärts gefräst Wide Jaw Punch medium 15° up milled	Breitmaulstanze klein 15° aufwärts gefräst Wide Jaw Punch small 15° up milled	Breitmaulstanze klein 45° aufwärts gefräst Wide Jaw Punch small 45° up milled
		 L = 5,0 mm · B = 4,5 mm	 L = 5,0 mm · B = 3,5 mm	 L = 6,0 mm · B = 2,5 mm	 L = 6,0 mm · B = 2,0 mm
gerade · straight 	3,5	41-05303-50	41-06003-50	41-06803-50	41-06983-50
30° rechts · 30° right 	3,5	41-05313-50	41-06013-50	41-06813-50	
30° links · 30° left 	3,5	41-05333-50	41-06033-50	41-06833-50	
45° rechts · 45° right 	3,5	41-05353-50	41-06053-50	41-06853-50	
45° links · 45° left 	3,5	41-05373-50	41-06073-50	41-06873-50	
7° auf · 7° up 	3,5	41-05393-50	41-06093-50	41-06893-50	
7° auf · 7° down 	3,5	41-05413-50	41-06113-50	41-06913-50	
15°auf · 15 up 	2,7	41-05433-50	41-06133-50	41-06933-50	
15° ab · 15° down 	3,5	41-05453-50	41-06153-50	41-06953-50	





ENDOTECH



M E D I C A L S Y S T E M S

Arthroskopie / Arthroscopy

Alle Instrumente mit Überlastungsschutz
All Instruments with Overload Protection















	∅ mm	45° Hakenschere 45° Hook Scissors	45° Stanze mit Schaufel 45° Punch with Scoop	45° Stanze stumpf 45° Punch blunt	90° Stanze mit Schaufel 90° Punch with Scoop	90° Stanze stumpf 90° Punch blunt
			 L = 4,5 mm · B = 1,6 mm	 L = 4,5 mm · B = 1,6 mm	 L = 4,5 mm · B = 1,6 mm	 L = 4,5 mm · B = 1,6 mm
rechts abgewinkelt right angled	3,5	41-02703-50	41-04103-50	41-04203-50	41-04503-50	41-04603-50
links abgewinkelt left angled	3,5	41-02803-50	41-04303-50	41-04403-50	41-04703-50	41-04803-50

	∅ mm	90° Breitmaulstanze mittel 90° Wide Jaw Punch medium	90° Breitmaulstanze klein 90° Wide Jaw Punch small
		 L = 7,0 mm · B = 3,0 mm	 L = 7,0 mm · B = 1,8 mm
rechts abgewinkelt right angled	3,5	41-07403-50	41-07603-50
links abgewinkelt left angled	3,5	41-07503-50	41-07703-50

Arthroskopie / Arthroscopy

Alle Instrumente mit Überlastungsschutz
All Instruments with Overload Protection



	ø mm	Scherenstanze Scissors Punch  L = 5,0 mm · B = 0,8 mm	Scherenstanze 15° aufwärts geätzt Scissors Punch 15° up milled  L = 5,0 mm · B = 0,8 mm	Stanze Retrograd Schnitt links Punch Retrograde Cut left  L = 4,0 mm · B = 2,5 mm	Stanze Retrograd Schnitt rechts Punch Retrograde Cut right  L = 4,0 mm · B = 2,5 mm
gerade · straight 	3,5	41-07003-50	41-07203-50	41-07803-50	41-07903-50
30° rechts · 30° right 	3,5	41-07013-50	41-07203-50		
30° links · 30° left 	3,5	41-07033-50	41-07233-50		
45° rechts · 45° right 	3,5	41-07053-50	41-07253-50		
45° links · 45° left 	3,5	41-07073-50	41-07273-50		
7° auf · 7° up 	3,5	41-07093-50	41-07293-50		
7° auf · 7° down 	3,5	41-07113-50	41-07313-50		
15° auf · 15 up 	3,5	41-07133-50	41-07333-50		
15° ab · 15° down 	3,5	41-07153-50	41-07353-50		

ENDOTECH

M E D I C A L S Y S T E M S

Arthroskopie / Arthroscopy

Alle Instrumente mit Überlastungsschutz
All Instruments with Overload Protection



	ø mm	Fasszange Grasping Forceps	Fasszange 1x2 Zähne Grasping Forceps 1x2Teeth	Fasszange 1x2 Zähne Grasping Forceps 1x2 Teeth	Fass- und Biopsiezange Grasping and Biopsy Forceps	Biopsie-Löffel- Zange BiopsySpoon Forceps
ohne Sperre without Ratched	2,7					
	3,5	41-08002-70				
		41-08003-50	41-08203-50	41-08403-50	41-08603-50	41-08803-50

Arthroskopie Instrumente ohne Feder
Arthroscopy Instruments without Spring

Fig. 2

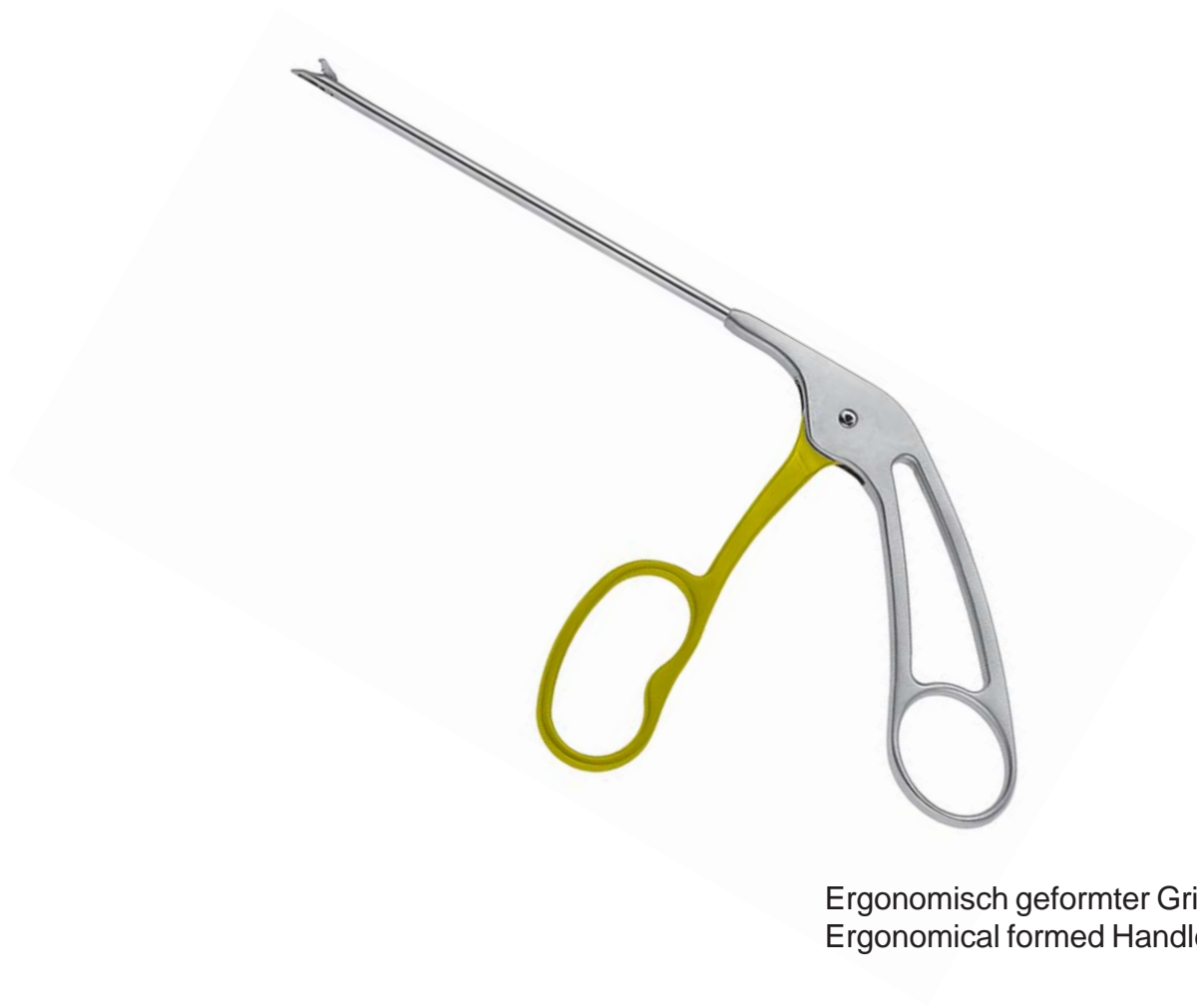

Ergonomisch geformter Griff
Ergonomical formed Handle

Arthroskopie / Arthroscopy

Alle Instrumente mit Überlastungsschutz
All Instruments with Overload Protection















	ø mm	Hakenschere Hook Scissors	Hakenstanze mit Schaufel Hook Punch with Scoop	Hakenstanze abgesetzt Hook Punch set down	Hakenstanze Schnitt eckig Hook Punch Cut angular
			 L = 5,0 mm · B = 1,6 mm	 L = 5,0 mm · B = 1,6 mm	 L = 5,0 mm · B = 1,6 mm
gerade · straight	2,7	42-02502-70	42-02902-70	42-03502-70	
	3,5	42-02503-50	42-02903-50	42-03503-50	42-03703-50
30° rechts · 30° right	2,7	42-02512-70	42-02912-70	42-03512-70	
	3,5	42-02513-50	42-02913-50	42-03513-50	42-03713-50
30° links · 30° left	2,7	42-02532-70	42-02932-70	42-03532-70	
	3,5	42-02533-50	42-02933-50	42-03533-50	42-03733-50
45° rechts · 45° right	2,7	42-02552-70	42-02952-70	42-03552-70	
	3,5	42-02553-50	42-02953-50	42-03553-50	42-03753-50
45° links · 45° left	2,7	42-02572-70	42-02972-70	42-03572-70	
	3,5	42-02573-50	42-02973-50	42-03573-50	42-03773-50
7° auf · 7° up	2,7	42-02592-70	42-02992-70	42-03592-70	
	3,5	42-02593-50	42-02993-50	42-03593-50	42-03793-50
7° auf · 7° down	2,7	42-02612-70	42-03012-70	42-03612-70	
	3,5	42-02613-50	42-03013-50	42-03613-50	42-03813-50
15° auf · 15 up	2,7	42-02632-70	42-03032-70	42-03632-70	
	3,5	42-02633-50	42-03033-50	42-03633-50	42-03833-50
15° ab · 15° down	2,7	42-02652-70	42-03052-70	42-03652-70	
	3,5	42-02653-50	42-03053-50	42-03653-50	42-03853-50

Arthroskopie / Arthroscopy

Alle Instrumente mit Überlastungsschutz
All Instruments with Overload Protection













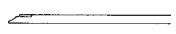

	ø mm	Hakenstanze 15° aufwärts gefräst Hook Hook Punch 15° up milled  L = 5,0 mm · B = 1,6 mm	Breitmaulstanze groß Wide Jaw Punch large  L = 5,0 mm · B = 4,5 mm	Breitmaulstanze mittel Wide Jaw Punch medium  L = 5,0 mm · B = 3,5 mm	Breitmaulstanze klein Wide Jaw Punch small  L = 6,0 mm · B = 2,5 mm
gerade · straight 	3,5	42-03903-50	42-04903-50	42-05603-50	42-06303-50
30° rechts · 30° right 	3,5	42-03913-50	42-04913-50	42-05613-50	42-06313-50
30° links · 30° left 	3,5	42-03933-50	42-04933-50	42-05633-50	42-06333-50
45° rechts · 45° right 	3,5	42-03953-50	42-04953-50	42-05653-50	42-06353-50
45° links · 45° left 	3,5	42-03973-50	42-04973-50	42-05673-50	42-06373-50
7° auf · 7° up 	3,5	42-03993-50	42-04993-50	42-05693-50	42-06393-50
7° auf · 7° down 	3,5	42-04013-50	42-05013-50	42-05713-50	42-06413-50
15° auf · 15 up 	3,5	42-04033-50	42-05033-50	42-05733-50	42-06433-50
15° ab · 15° down 	3,5	42-04053-50	42-05053-50	42-05753-50	42-06453-50

Arthroskopie / Arthroscopy

Alle Instrumente mit Überlastungsschutz
All Instruments with Overload Protection



	ø mm	Breitmaulstanze groß 15°aufwärts gefräst Wide Jaw Punch large 15° up milled	Breitmaulstanze mittel 15°aufwärts gefräst Wide Jaw Punch medium 15° up milled	Breitmaulstanze klein 15° aufwärts gefräst Wide Jaw Punch small 15° up milled	Breitmaulstanze klein 45° aufwärts gefräst Wide Jaw Punch small 45° up milled
		 L = 5,0 mm · B = 4,5 mm	 L = 5,0 mm · B = 3,5 mm	 L = 6,0 mm · B = 2,5 mm	 L = 6,0 mm · B = 2,0 mm
gerade · straight 	3,5	42-05303-50	42-06003-50	42-06803-50	42-06983-50
30° rechts · 30° right 	3,5	42-05313-50	42-06013-50	42-06813-50	
30° links · 30° left 	3,5	42-05333-50	42-06033-50	42-06833-50	
45° rechts · 45° right 	3,5	42-05353-50	42-06053-50	42-06853-50	
45° links · 45° left 	3,5	42-05373-50	42-06073-50	42-06873-50	
7° auf · 7° up 	3,5	42-05393-50	42-06093-50	42-06893-50	
7° auf · 7° down 	3,5	42-05413-50	42-06113-50	42-06913-50	
15°auf · 15 up 	2,7	42-05433-50	42-06133-50	42-06933-50	
15° ab · 15° down 	3,5	42-05453-50	42-06153-50	42-06953-50	





ENDOTECH



M E D I C A L S Y S T E M S

Arthroskopie / Arthroscopy

Alle Instrumente mit Überlastungsschutz
All Instruments with Overload Protection















	∅ mm	45° Hakenschere 45° Hook Scissors 	45° Stanze mit Schaufel 45° Punch with Scoop  L = 4,5 mm · B = 1,6 mm	45° Stanze stumpf 45° Punch blunt  L = 4,5 mm · B = 1,6 mm	90° Stanze mit Schaufel 90° Punch with Scoop  L = 4,5 mm · B = 1,6 mm	90° Stanze stumpf 90° Punch blunt  L = 4,5 mm · B = 1,6 mm
rechts abgewinkelt right angled	3,5	42-02703-50	42-04103-50	42-04203-50	42-04503-50	42-04603-50
links abgewinkelt left angled	3,5	42-02803-50	42-04303-50	42-04403-50	42-04703-50	42-04803-50

	∅ mm	90° Breitmaulstanze mittel 90° Wide Jaw Punch medium  L = 7,0 mm · B = 3,0 mm	90° Breitmaulstanze klein 90° Wide Jaw Punch small  L = 7,0 mm · B = 1,8 mm
rechts abgewinkelt right angled	3,5	42-07403-50	42-07603-50
links abgewinkelt left angled	3,5	42-07503-50	42-07703-50

Arthroskopie / Arthroscopy

Alle Instrumente mit Überlastungsschutz
All Instruments with Overload Protection



	ø mm	Scherenstanze Scissors Punch  L = 5,0 mm · B = 0,8 mm	Scherenstanze 15° aufwärts geätzt Scissors Punch 15° up milled  L = 5,0 mm · B = 0,8 mm	Stanze Retrograd Schnitt links Punch Retrograde Cut left  L = 4,0 mm · B = 2,5 mm	Stanze Retrograd Schnitt rechts Punch Retrograde Cut right  L = 4,0 mm · B = 2,5 mm
gerade · straight 	3,5	42-07003-50	42-07203-50	42-07803-50	42-07903-50
30° rechts · 30° right 	3,5	42-07013-50	42-07203-50		
30° links · 30° left 	3,5	42-07033-50	42-07233-50		
45° rechts · 45° right 	3,5	42-07053-50	42-07253-50		
45° links · 45° left 	3,5	42-07073-50	42-07273-50		
7° auf · 7° up 	3,5	42-07093-50	42-07293-50		
7° auf · 7° down 	3,5	42-07113-50	42-07313-50		
15° auf · 15 up 	3,5	42-07133-50	42-07333-50		
15° ab · 15° down 	3,5	42-07153-50	42-07353-50		

ENDOTECH

M E D I C A L S Y S T E M S

Arthroskopie / Arthroscopy

Alle Instrumente mit Überlastungsschutz
All Instruments with Overload Protection



	ø mm	Fasszange Grasping Forceps	Fasszange 1x2 Zähne Grasping Forceps 1x2Teeth	Fasszange 1x2 Zähne Grasping Forceps 1x2 Teeth	Fass- und Biopsiezange Grasping and Biopsy Forceps	Biopsie-Löffel- Zange BiopsySpoon Forceps
ohne Sperre without Ratched	2,7					
	3,5	42-08002-70				
		42-08003-50	42-08203-50	42-08403-50	42-08603-50	42-08803-50

Arthroskopie Instrumente ohne Feder
Arthroscopy Instruments without Spring

Fig. 3













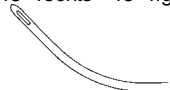

Ergonomisch geformter Griff
Ergonomical formed Handle

Arthroskopie / Arthroscopy

Alle Instrumente mit Überlastungsschutz
All Instruments with Overload Protection



	ø mm	Hakenschere Hook Scissors	Hakenstanze mit Schaufel Hook Punch with Scoop	Hakenstanze abgesetzt Hook Punch set down	Hakenstanze Schnitt eckig Hook Punch Cut angular
			 L = 5,0 mm · B = 1,6 mm	 L = 5,0 mm · B = 1,6 mm	 L = 5,0 mm · B = 1,6 mm
gerade · straight	2,7	43-02502-70	43-02902-70	43-03502-70	
	3,5	43-02503-50	43-02903-50	43-03503-50	43-03703-50
30° rechts · 30° right	2,7	43-02512-70	43-02912-70	43-03512-70	
	3,5	43-02513-50	43-02913-50	43-03513-50	43-03713-50
30° links · 30° left	2,7	43-02532-70	43-02932-70	43-03532-70	
	3,5	43-02533-50	43-02933-50	43-03533-50	43-03733-50
45° rechts · 45° right	2,7	43-02552-70	43-02952-70	43-03552-70	
	3,5	43-02553-50	43-02953-50	43-03553-50	43-03753-50
45° links · 45° left	2,7	43-02572-70	43-02972-70	43-03572-70	
	3,5	43-02573-50	43-02973-50	43-03573-50	43-03773-50
7° auf · 7° up	2,7	43-02592-70	43-02992-70	43-03592-70	
	3,5	43-02593-50	43-02993-50	43-03593-50	43-03793-50
7° auf · 7° down	2,7	43-02612-70	43-03012-70	43-03612-70	
	3,5	43-02613-50	43-03013-50	43-03613-50	43-03813-50
15° auf · 15 up	2,7	43-02632-70	43-03032-70	43-03632-70	
	3,5	43-02633-50	43-03033-50	43-03633-50	43-03833-50
15° ab · 15° down	2,7	43-02652-70	43-03052-70	43-03652-70	
	3,5	43-02653-50	43-03053-50	43-03653-50	43-03853-50

Arthroskopie / Arthroscopy

Alle Instrumente mit Überlastungsschutz
All Instruments with Overload Protection













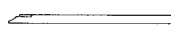

	ø mm	Hakenstanze 15° aufwärts gefräst Hook Punch 15° up milled	Breitmaulstanze groß Wide Jaw Punch large	Breitmaulstanze mittel Wide Jaw Punch medium	Breitmaulstanze klein Wide Jaw Punch small
		 L = 5,0 mm · B = 1,6 mm	 L = 5,0 mm · B = 4,5 mm	 L = 5,0 mm · B = 3,5 mm	 L = 6,0 mm · B = 2,5 mm
gerade · straight 	3,5	43-03903-50	43-04903-50	43-05603-50	43-06303-50
30° rechts · 30° right 	3,5	43-03913-50	43-04913-50	43-05613-50	43-06313-50
30° links · 30° left 	3,5	43-03933-50	43-04933-50	43-05633-50	43-06333-50
45° rechts · 45° right 	3,5	43-03953-50	43-04953-50	43-05653-50	43-06353-50
45° links · 45° left 	3,5	43-03973-50	43-04973-50	43-05673-50	43-06373-50
7° auf · 7° up 	3,5	43-03993-50	43-04993-50	43-05693-50	43-06393-50
7° auf · 7° down 	3,5	43-04013-50	43-05013-50	43-05713-50	43-06413-50
15° auf · 15 up 	3,5	43-04033-50	43-05033-50	43-05733-50	43-0643-3-50
15° ab · 15° down 	3,5	43-04053-50	43-05053-50	43-05753-50	43-06453-50

Arthroskopie / Arthroscopy

Alle Instrumente mit Überlastungsschutz
All Instruments with Overload Protection



	ø mm	Breitmaulstanze groß 15°aufwärts gefräst Wide Jaw Punch large 15° up milled	Breitmaulstanze mittel 15°aufwärts gefräst Wide Jaw Punch medium 15° up milled	Breitmaulstanze klein 15° aufwärts gefräst Wide Jaw Punch small 15° up milled	Breitmaulstanze klein 45° aufwärts gefräst Wide Jaw Punch small 45° up milled
		 L = 5,0 mm · B = 4,5 mm	 L = 5,0 mm · B = 3,5 mm	 L = 6,0 mm · B = 2,5 mm	 L = 6,0 mm · B = 2,0 mm
gerade · straight 	3,5	43-05303-50	43-06003-50	43-06803-50	43-06983-50
30° rechts · 30° right 	3,5	43-05313-50	43-06013-50	43-06813-50	
30° links · 30° left 	3,5	43-05333-50	43-06033-50	43-06833-50	
45° rechts · 45° right 	3,5	43-05353-50	43-06053-50	43-06853-50	
45° links · 45° left 	3,5	43-05373-50	43-06073-50	43-06873-50	
7° auf · 7° up 	3,5	43-05393-50	43-06093-50	43-06893-50	
7° auf · 7° down 	3,5	43-05413-50	43-06113-50	43-06913-50	
15°auf · 15 up 	2,7	43-05433-50	43-06133-50	43-06933-50	
15° ab · 15° down 	3,5	43-05453-50	43-06153-50	43-06953-50	





ENDOTECH



M E D I C A L S Y S T E M S

Arthroskopie / Arthroscopy

Alle Instrumente mit Überlastungsschutz
All Instruments with Overload Protection















	∅ mm	45° Hakenschere 45° Hook Scissors 	45° Stanze mit Schaufel 45° Punch with Scoop  L = 4,5 mm · B = 1,6 mm	45° Stanze stumpf 45° Punch blunt  L = 4,5 mm · B = 1,6 mm	90° Stanze mit Schaufel 90° Punch with Scoop  L = 4,5 mm · B = 1,6 mm	90° Stanze stumpf 90° Punch blunt  L = 4,5 mm · B = 1,6 mm
rechts abgewinkelt right angled	3,5	43-02703-50	43-04103-50	43-04203-50	43-04503-50	43-04603-50
links abgewinkelt left angled	3,5	43-02803-50	43-04303-50	43-04403-50	43-04703-50	43-04803-50

	∅ mm	90° Breitmaulstanze mittel Wide Jaw Punch 90° medium  L = 7,0 mm · B = 3,0 mm	90° Breitmaulstanze klein Wide Jaw Punch 90° small  L = 7,0 mm · B = 1,8 mm
rechts abgewinkelt right angled	3,5	43-07403-50	43-07603-50
links abgewinkelt left angled	3,5	43-07503-50	43-07703-50

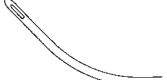
Arthroskopie / Arthroscopy

Alle Instrumente mit Überlastungsschutz
All Instruments with Overload Protection



	ø mm	Scherenstanze Scissors Punch  L = 5,0 mm · B = 0,8 mm	Scherenstanze 15° aufwärts geätzt Scissors Punch 15° up milled  L = 5,0 mm · B = 0,8 mm	Stanze Retrograd Schnitt links Punch Retrograde Cut left  L = 4,0 mm · B = 2,5 mm	Stanze Retrograd Schnitt rechts Punch Retrograde Cut right  L = 4,0 mm · B = 2,5 mm
gerade · straight 	3,5	43-07003-50	43-07203-50	43-07803-50	43-07903-50
30° rechts · 30° right 	3,5	43-07013-50	43-07203-50		
30° links · 30° left 	3,5	43-07033-50	43-07233-50		
45° rechts · 45° right 	3,5	43-07053-50	43-07253-50		
45° links · 45° left 	3,5	43-07073-50	43-07273-50		
7° auf · 7° up 	3,5	43-07093-50	43-07293-50		
7° auf · 7° down 	3,5	43-07113-50	43-07313-50		
15° auf · 15 up 	3,5	43-07133-50	43-07333-50		
15° ab · 15° down 	3,5	43-07153-50	43-07353-50		





ENDOTECH

M E D I C A L S Y S T E M S

Arthroskopie / Arthroscopy

Alle Instrumente mit Überlastungsschutz
All Instruments with Overload Protection



	∅ mm	Fasszange Grasping Forceps	Fasszange 1x2 Zähne Grasping Forceps 1x2Teeth	Fasszange 1x2 Zähne Grasping Forceps 1x2 Teeth	Fass- und Biopsiezange Grasping and Biopsy Forceps	Biopsie-Löffel- Zange BiopsySpoon Forceps
ohne Sperre without Ratched	2,7					
	3,5	43-08002-70	43-08003-50	43-08203-50	43-08403-50	43-08603-50

Arthroskopie Instrumente
Arthroscopy Instruments

Fig. 4













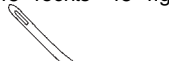

Ergonomisch geformter Griff
Ergonomical formed Handle

Arthroskopie / Arthroscopy

Alle Instrumente mit Überlastungsschutz
All Instruments with Overload Protection















	ø mm	Hakenschere Hook Scissors	Hakenstanze mit Schaufel Hook Punch with Scoop	Hakenstanze abgesetzt Hook Punch set down	Hakenstanze Schnitt eckig Hook Punch Cut angular
			 L = 5,0 mm · B = 1,6 mm	 L = 5,0 mm · B = 1,6 mm	 L = 5,0 mm · B = 1,6 mm
gerade · straight	2,7	44-02502-70	44-02902-70	44-03502-70	
	3,5	44-02503-50	44-02903-50	44-03503-50	44-03703-50
30° rechts · 30° right	2,7	44-02512-70	44-02912-70	44-03512-70	
	3,5	44-02513-50	44-02913-50	44-03513-50	44-03713-50
30° links · 30° left	2,7	44-02532-70	44-02932-70	44-03532-70	
	3,5	44-02533-50	44-02933-50	44-03533-50	44-03733-50
45° rechts · 45° right	2,7	44-02552-70	44-02952-70	44-0-3552-70	
	3,5	44-02553-50	44-02953-50	44-03553-50	44-03753-50
45° links · 45° left	2,7	44-02572-70	44-02972-70	44-03572-70	
	3,5	44-02573-50	44-02973-50	44-03573-50	44-03773-50
7° auf · 7° up	2,7	44-02592-70	44-02992-70	44-03592-70	
	3,5	44-02593-50	44-02993-50	44-03593-50	44-03793-50
7° auf · 7° down	2,7	44-02612-70	44-03012-70	44-03612-70	
	3,5	44-026134-50	44-03013-50	44-03613-50	44-03813-50
15° auf · 15 up	2,7	44-02632-70	44-03032-70	44-03632-70	
	3,5	44-02633-50	44-03033-50	44-03633-50	44-03833-50
15° ab · 15° down	2,7	44-02652-70	44-0-305-270	44-03652-70	
	3,5	44-02653-50	44-03053-50	44-03653-50	44-03853-50

Arthroskopie / Arthroscopy

Alle Instrumente mit Überlastungsschutz
All Instruments with Overload Protection



	ø mm	Hakenstanze 15° aufwärts gefräst Hook Punch 15° up milled	Breitmaulstanze groß Wide Jaw Punch large	Breitmaulstanze mittel Wide Jaw Punch medium	Breitmaulstanze klein Wide Jaw Punch small
		 L = 5,0 mm · B = 1,6 mm	 L = 5,0 mm · B = 4,5 mm	 L = 5,0 mm · B = 3,5 mm	 L = 6,0 mm · B = 2,5 mm
gerade · straight 	3,5	44-03903-50	44-04903-50	44-05603-50	44-06303-50
30° rechts · 30° right 	3,5	44-03913-50	44-04913-50	44-05613-50	44-06313-50
30° links · 30° left 	3,5	44-03933-50	44-04933-50	44-05633-50	44-06333-50
45° rechts · 45° right 	3,5	44-03953-50	44-04953-50	44-05653-50	44-06353-50
45° links · 45° left 	3,5	44-03973-50	44-04973-50	44-05673-50	44-06373-50
7° auf · 7° up 	3,5	44-03993-50	44-04993-50	44-05693-50	44-06393-50
7° auf · 7° down 	3,5	44-04013-50	44-05013-50	44-05713-50	44-06413-50
15° auf · 15 up 	3,5	44-04033-50	44-05033-50	44-05733-50	44-06433-50
15° ab · 15° down 	3,5	44-04053-50	44-05053-50	44-05753-50	44-06453-50













ENDOTECH

M E D I C A L S Y S T E M S

Arthroskopie / Arthroscopy

Alle Instrumente mit Überlastungsschutz
All Instruments with Overload Protection



	ø mm	Breitmaulstanze groß 15°aufwärts gefräst Wide Jaw Punch large 15° up milled	Breitmaulstanze mittel 15°aufwärts gefräst Wide Jaw Punch medium 15° up milled	Breitmaulstanze klein 15° aufwärts gefräst Wide Jaw Punch small 15° up milled	Breitmaulstanze klein 45° aufwärts gefräst Wide Jaw Punch small 45° up milled
		 L = 5,0 mm · B = 4,5 mm	 L = 5,0 mm · B = 3,5 mm	 L = 6,0 mm · B = 2,5 mm	 L = 6,0 mm · B = 2,0 mm
gerade · straight 	3,5	44-05303-50	44-06003-50	44-06803-50	44-06983-50
30° rechts · 30° right 	3,5	44-05313-50	44-06013-50	44-06813-50	
30° links · 30° left 	3,5	44-05333-50	44-06033-50	44-06833-50	
45° rechts · 45° right 	3,5	44-05353-50	44-06053-50	44-06853-50	
45° links · 45° left 	3,5	44-05373-50	44-06073-50	44-06873-50	
7° auf · 7° up 	3,5	44-05393-50	44-06093-50	44-06893-50	
7° auf · 7° down 	3,5	44-05413-50	44-06113-50	44-06913-50	
15°auf · 15 up 	2,7	44-05433-50	44-06133-50	44-06933-50	
15° ab · 15° down 	3,5	44-05453-50	44-06153-50	44-06953-50	





ENDOTECH

M E D I C A L S Y S T E M S

Arthroskopie / Arthroscopy

Alle Instrumente mit Überlastungsschutz
All Instruments with Overload Protection



	∅ mm	45° Hakenschere 45° Hook Scissors	45° Stanze mit Schaufel 45° Punch with Scoop	45° Stanze stumpf 45° Punch blunt	90° Stanze mit Schaufel 90° Punch with Scoop	90° Stanze stumpf 90° Punch blunt
			 L = 4,5 mm · B = 1,6 mm	 L = 4,5 mm · B = 1,6 mm	 L = 4,5 mm · B = 1,6 mm	 L = 4,5 mm · B = 1,6 mm
rechts abgewinkelt right angled	3,5	44-02703-50	44-04103-50	44-04203-50	44-04503-50	44-04603-50
links abgewinkelt left angled	3,5	44-02803-50	44-04303-50	44-04403-50	44-04703-50	44-04803-50

	∅ mm	90° Breitmaulstanze mittel 90° Wide Jaw Punch medium	90° Breitmaulstanze klein 90° Wide Jaw Punch small
		 L = 7,0 mm · B = 3,0 mm	 L = 7,0 mm · B = 1,8 mm
rechts abgewinkelt right angled	3,5	44-07403-50	44-07603-50
links abgewinkelt left angled	3,5	44-07503-50	44-07703-50













ENDOTECH

M E D I C A L S Y S T E M S

Arthroskopie / Arthroscopy

Alle Instrumente mit Überlastungsschutz
All Instruments with Overload Protection



	ø mm	Scherenstanze Scissors Punch	Scherenstanze 15° aufwärts geätzt Scissors Punch 15° up milled	Stanze Retrograd Schnitt links Punch Retrograde Cut left	Stanze Retrograd Schnitt rechts Punch Retrograde Cut right
		 L = 5,0 mm · B = 0,8 mm	 L = 5,0 mm · B = 0,8 mm	 L = 4,0 mm · B = 2,5 mm	 L = 4,0 mm · B = 2,5 mm
gerade · straight 	3,5	44-07003-50	44-07203-50	44-07803-50	44-07903-50
30° rechts · 30° right 	3,5	44-07013-50	44-07203-50		
30° links · 30° left 	3,5	44-07033-50	44-07233-50		
45° rechts · 45° right 	3,5	44-07053-50	44-07253-50		
45° links · 45° left 	3,5	44-07073-50	44-07273-50		
7° auf · 7° up 	3,5	44-07093-50	44-07293-50		
7° auf · 7° down 	3,5	44-07113-50	44-07313-50		
15° auf · 15 up 	3,5	44-07133-50	44-07333-50		
15° ab · 15° down 	3,5	44-07153-50	44-07353-50		

ENDOTECH

M E D I C A L S Y S T E M S

Arthroskopie / Arthroscopy

Alle Instrumente mit Überlastungsschutz
All Instruments with Overload Protection



	ø mm	Fasszange Grasping Forceps	Fasszange 1x2 Zähne Grasping Forceps 1x2Teeth	Fasszange 1x2 Zähne Grasping Forceps 1x2 Teeth	Fass- und Biopsiezange Grasping and Biopsy Forceps	Biopsie-Löffel- Zange BiopsySpoon Forceps
ohne Sperre without Ratched	2,7					
	3,5	44-08003-50	44-08203-50	44-08403-50	44-08603-50	44-08803-50